



louis poulsen

AJ GARDEN



DESIGN: ARNE JACOBSEN

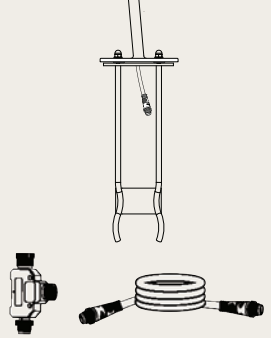

ANCHOR		
Bollard with anchor, T-connector, and 5 m. cable with plugs.		
Size:	Kelvin*	Black colour 
Large 954 mm 	2700K	24V: 5747306897
	3000K	24V: 5747306884
Small 504 mm 	2700K	24V: 5747306800
	3000K	24V: 5747306790



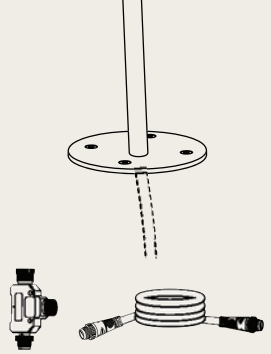

Requires installation by certified electrician.

BASEPLATE		
Bollard with baseplate, T-connector, and 5 m. cable with plugs.		
Size:	Kelvin*	Black colour 
Large 954 mm 	2700K	24V: 5747306868
	3000K	24V: 5747306855
Small 504 mm 	2700K	24V: 5747306774
	3000K	24V: 5747306761



Requires installation by certified electrician.

SPIKE		
Bollard with spike, T-connector, and 5 m. cable with plugs.		
Size:	Kelvin*	Black colour 
Large 954 mm 	2700K	24V: 5747306923
	3000K	24V: 5747306910
Small 504 mm 	2700K	24V: 5747306839
	3000K	24V: 5747306826

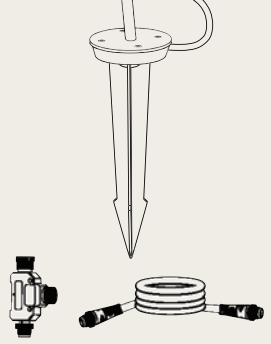

Does not require installation by certified electrician. Plug-and-Play.

* For 4000K please contact Louis Poulsen.

IMPORTANT: Adaptor must be bought separately:
A maximum of 6 AJ Garden bollards (6,5W) can be run by one adaptor.

Accessories:

Garden Adaptor box (60W).
EU: 5747407039
UK: 5747407042

Garden T-connector 5747405303
Garden cable 5 m. 5747405316

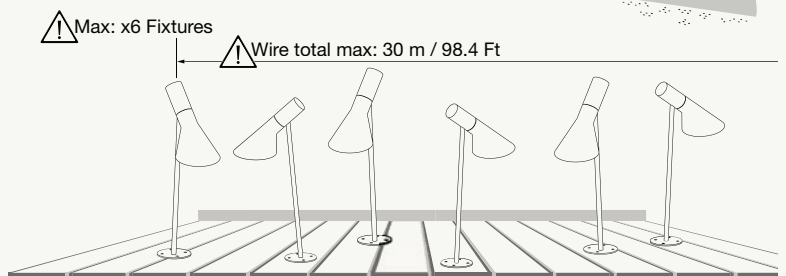
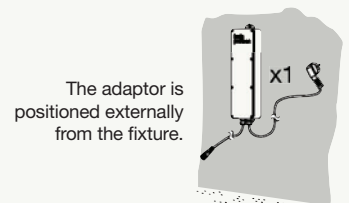

louis poulsen

AJ GARDEN

DESIGN: ARNE JACOBSEN

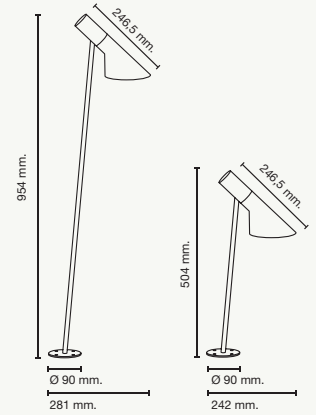

Bollard with anchor unit to be fixed in concrete

Requires installation by certified electrician.

Anchor unit to be fixed in concrete. Use installation tubes for inground installation, with enclosed cables running inside, for legal fixed installation.

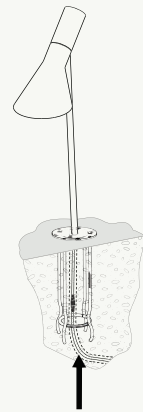

installation tubes

Bollard with baseplate for mounting on a surface.

Requires installation by certified electrician.

Two options for installation.

A) Mounting on a surface with overground installation. Enclosed cables running over the ground. When using T-connector for multiple bollards the connector must be easily accessible. The cables must be fixed for legal fixed installation.

B) Mounting on a surface with in-ground installation. Use installation tubes for in-ground installation, with enclosed cables running inside, for legal fixed installation.

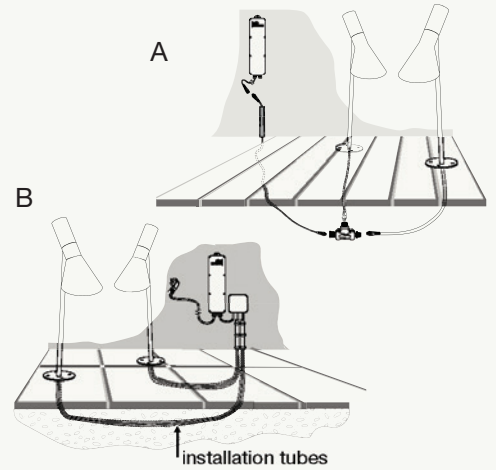

Bollard with spike

Plug-and-Play

Put the bollard with the spike into the ground. Let the enclosed cable 5 m. run over the ground. The bollard is connected to the adaptor using standard plugs delivered with the fixture. Plug-and-Play.

